

# feather&black

## Perfect Bedtimes

### Amelia Wardrobe

#### IMPORTANT READ CAREFULLY RETAIN FOR FUTURE REFERENCE

##### Thank you for buying the Amelia Wardrobe

- Please take a few quiet minutes to read these instructions
- Because of the size of this product we recommend that it is built in the room intended for use
- It is recommended that this product is assembled by two adults.
- As this product contains small parts please keep small children clear from the assembly area
- Before assembly please lay out all the parts on a clean protected surface and check that all parts are present with the parts checklist
- Save all packing until the product is fully assembly to avoid accidentally discarding fittings

#### PRODUCT SAFETY

- All assembly fastenings should always be tightened properly and care should be taken that no fittings are loose
- We recommend that you periodically check and ensure that all components are in their proper position, free from damage, and that all fittings are fully tightened
- Feather & Black strongly advise using the Anti-Tip wall fixings provided with this product however the wall fixing itself may need to be altered depending on your wall. If these fixings have been misplaced please contact our customer service team who will be more than happy to send you a replacement kit.

#### PRODUCT CARE











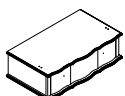





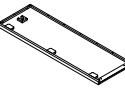







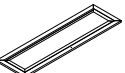

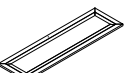
- Wipe clean using a soft damp cloth followed by dry cloth
- Do not use abrasives or cleaning products which may contain ammonia or solvents
- Take care when handling or moving the furniture. Careless handling can damage wooden furniture, try to lift rather than drag

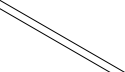
#### TOOLS REQUIRED:

- Please use Allen key part O (included) and Philips Head Screwdriver (not included) to assemble the Amelia Wardrobe



# ASSEMBLY INSTRUCTIONS

|   | PARTS   | QTY  |   | PARTS   | QTY                 |
|---|---|------|---|---|---------------------|
| A |    | 1PC  | L |    | 8PCS<br>Ø 6 x 35    |
| B |    | 1PC  | M |    | 10PCS<br>Ø 6 / Ø 16 |
| C |    | 1PC  | N |    | 2PCS<br>Ø 6 x 70    |
| D |    | 1PC  | O |    | 1PC<br>Ø 4          |
| E |    | 1PC  | P |    | 10PCS<br>Ø 10 x 20  |
| F |    | 1PC  | Q |    | 2PCS<br>Ø 4 x 30    |
| J |    | 2PCS | R |    | 32PCS<br>Ø 3 x 15   |
| G |   | 1PC  | S |    | 2PCS                |
| H |  | 1PC  | T |   | 12PCS<br>Ø 4 x 15   |
| I |  | 1PC  | U |  | 6PCS                |
| K |  | 4PCS | V |  | 2PCS                |
|   |   |      | W |  | 2PCS<br>Ø 4 x 30    |
|   |   |      | X |  | 4PCS                |
|   |   |      | Y |  | 4PCS<br>Ø 4 x 20    |
|   |   |      | Z |  | 2PCS                |

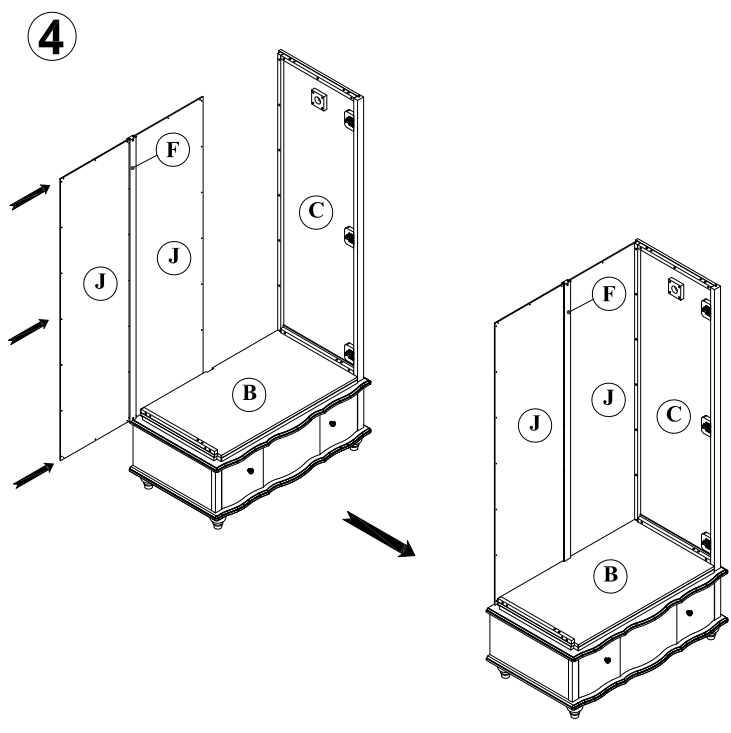
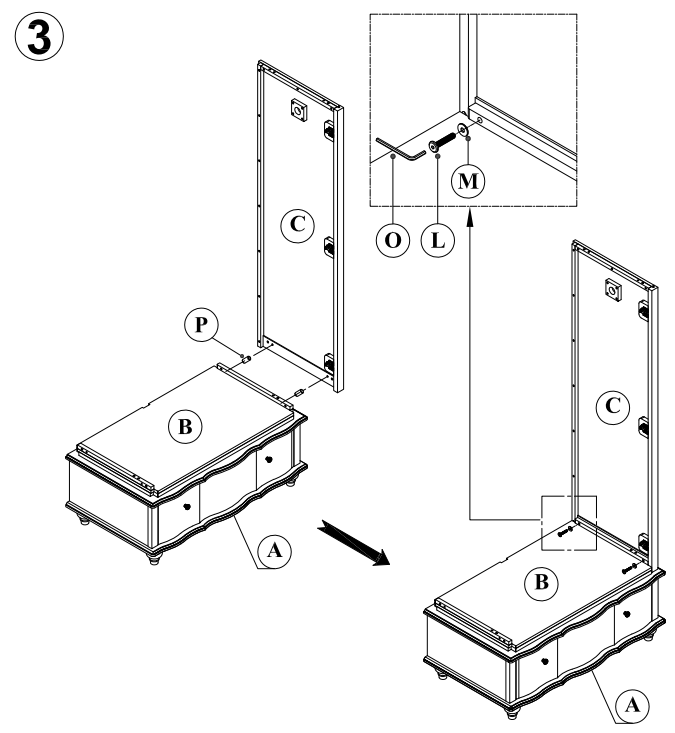
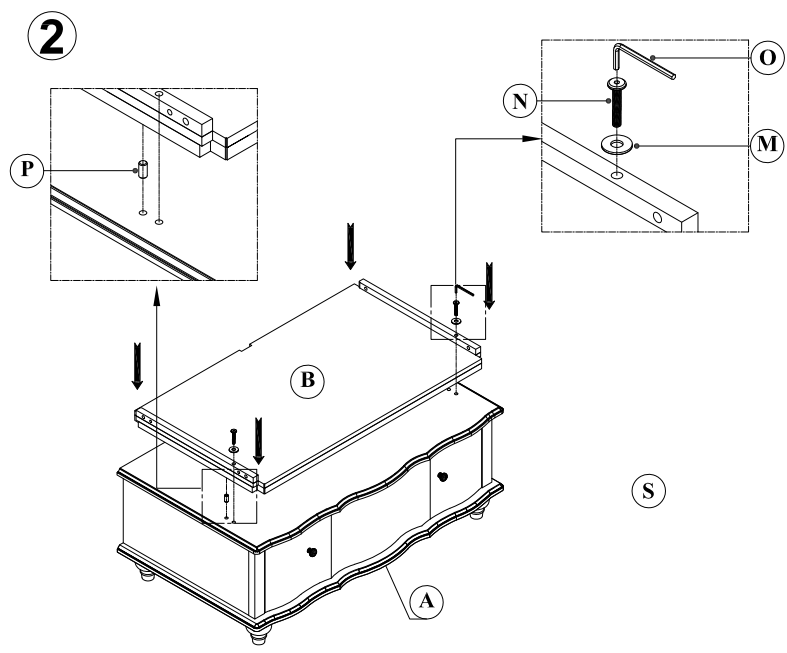
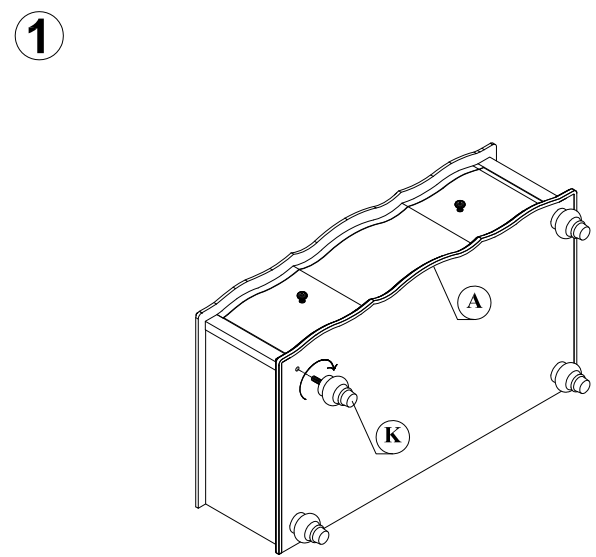

# ASSEMBLY INSTRUCTIONS

